

RCS-8 (NONcNZO8)

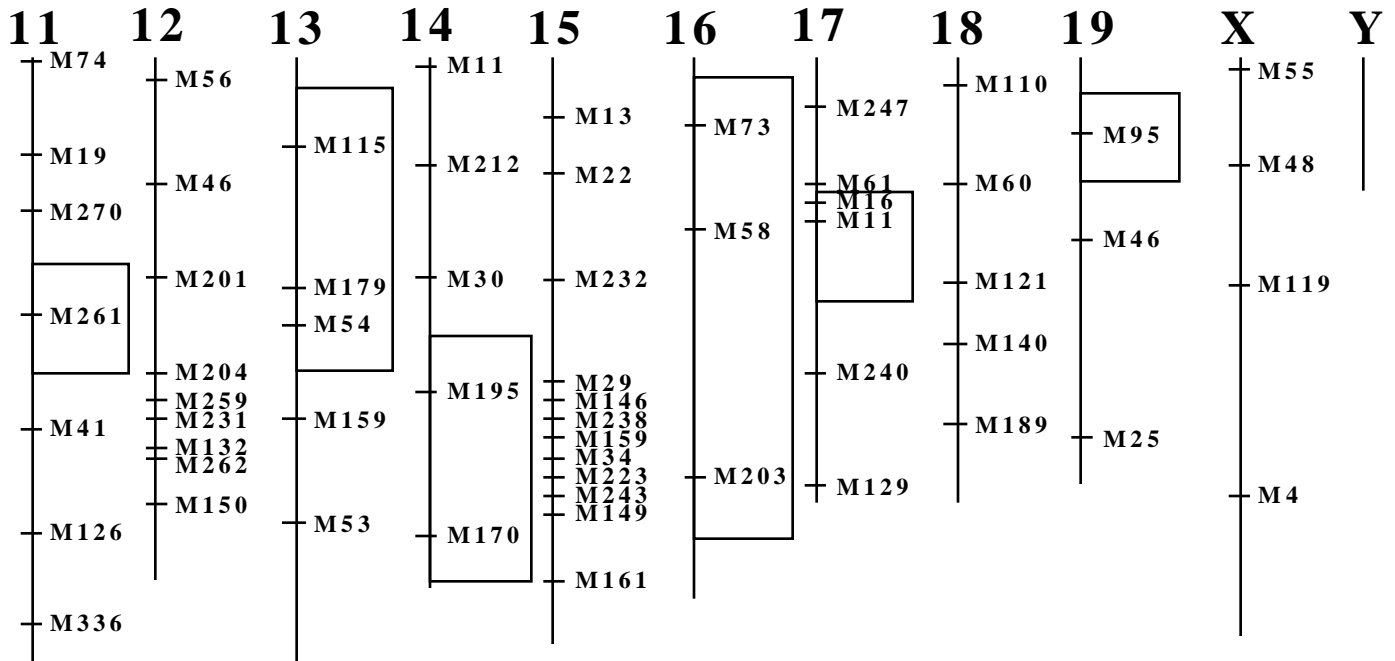
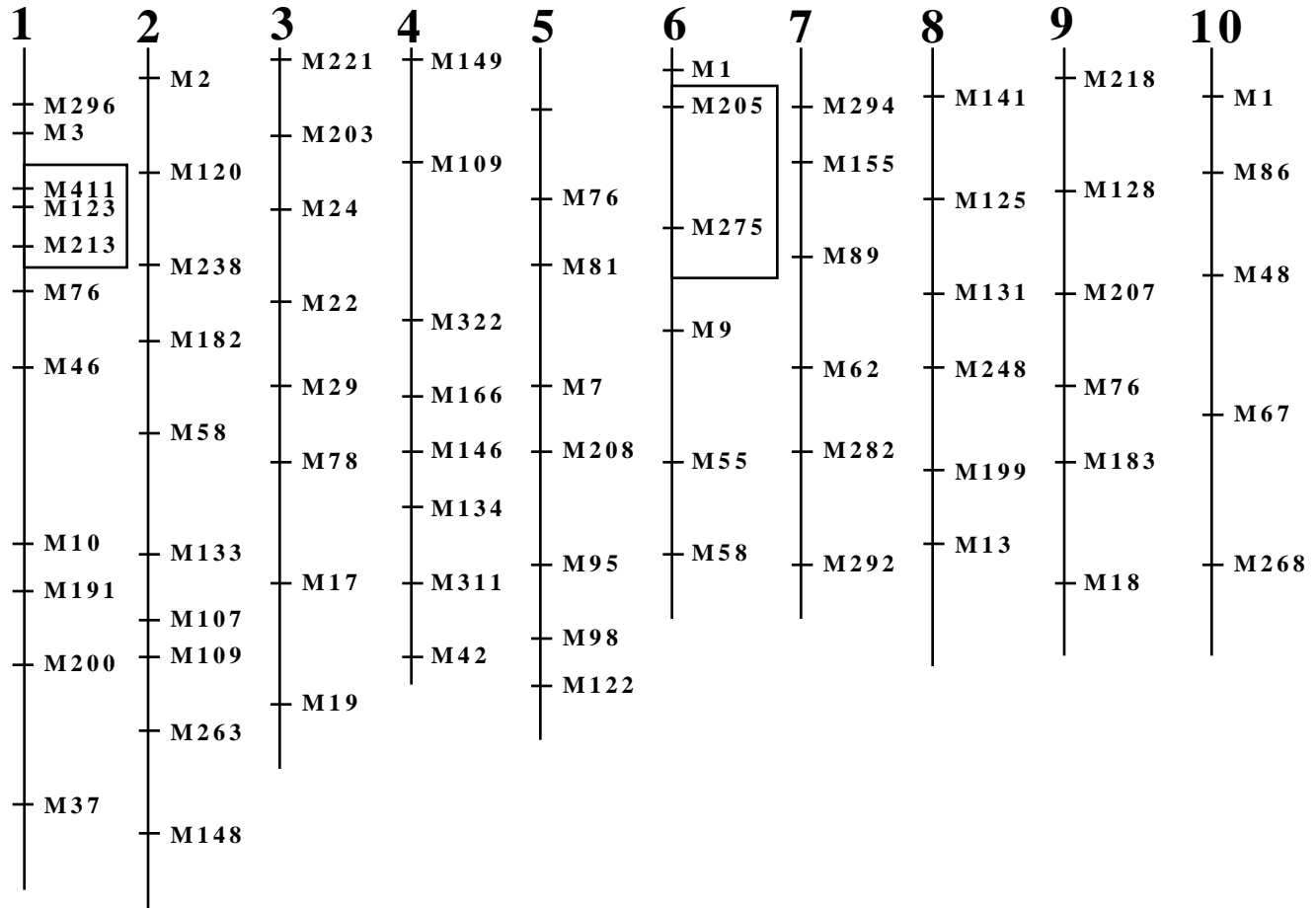

NZO-Derived

NON-Derived

Last Updated 3/15/2002